

# Fashion Freaks

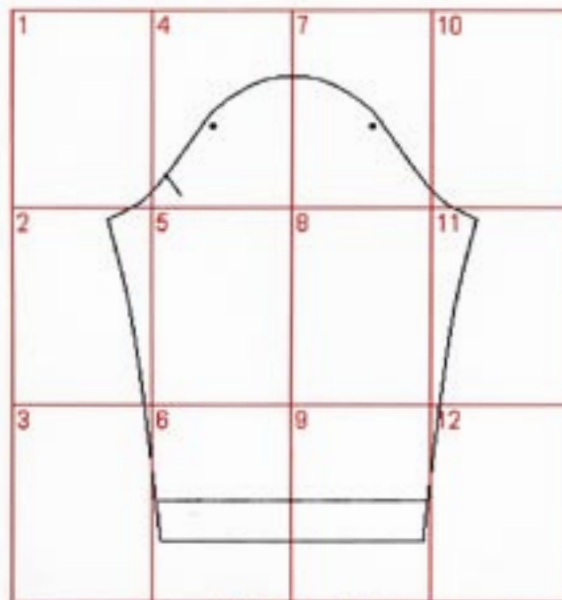

## PATTERN LAYOUT

### WOMEN'S SUITSTYLE JACKET - NORMAL SLEEVE



jacket in suitstyle  
normal sleeve

This is how the pattern pieces should go together to form the total pattern for the one piece sleeve of the women's suitstyle jacket.

Each paper in this pdf-file contains a numbered section from this pattern.

You shall put them together by matching the 'corner hooks' with each other.

Remember to print out on A4 paper (210 x 297 mm) to get the right measurements for your size.

Measure the distance between the 'corner hooks' to make sure you have the right size. The distance is (170 x 257 mm)

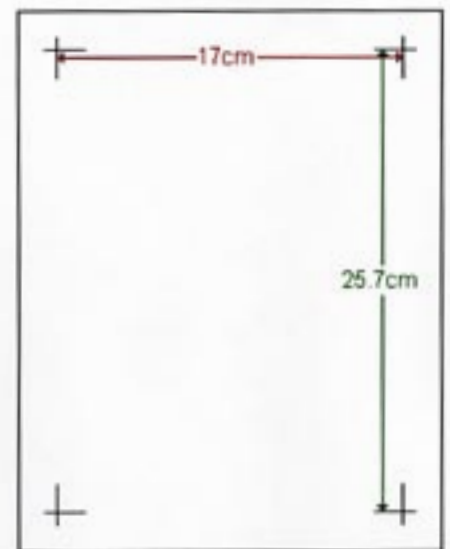

Women's Jacket 1: Sleeve - Normal (1 of 12)

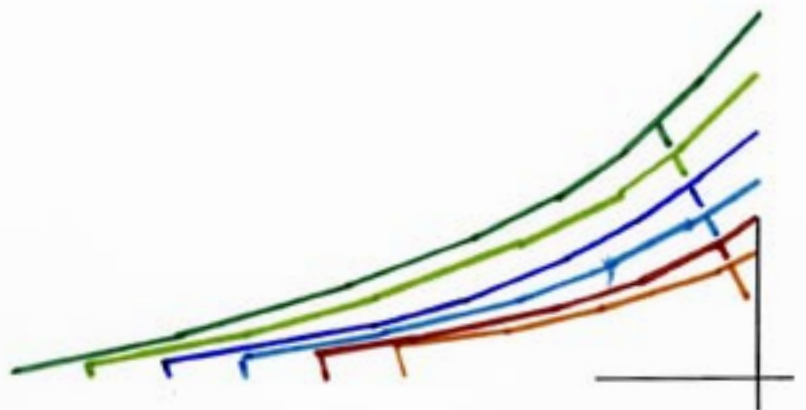
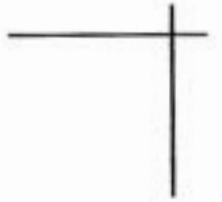

Women's Jacket 1: Sleeve - Normal (2 of 12)

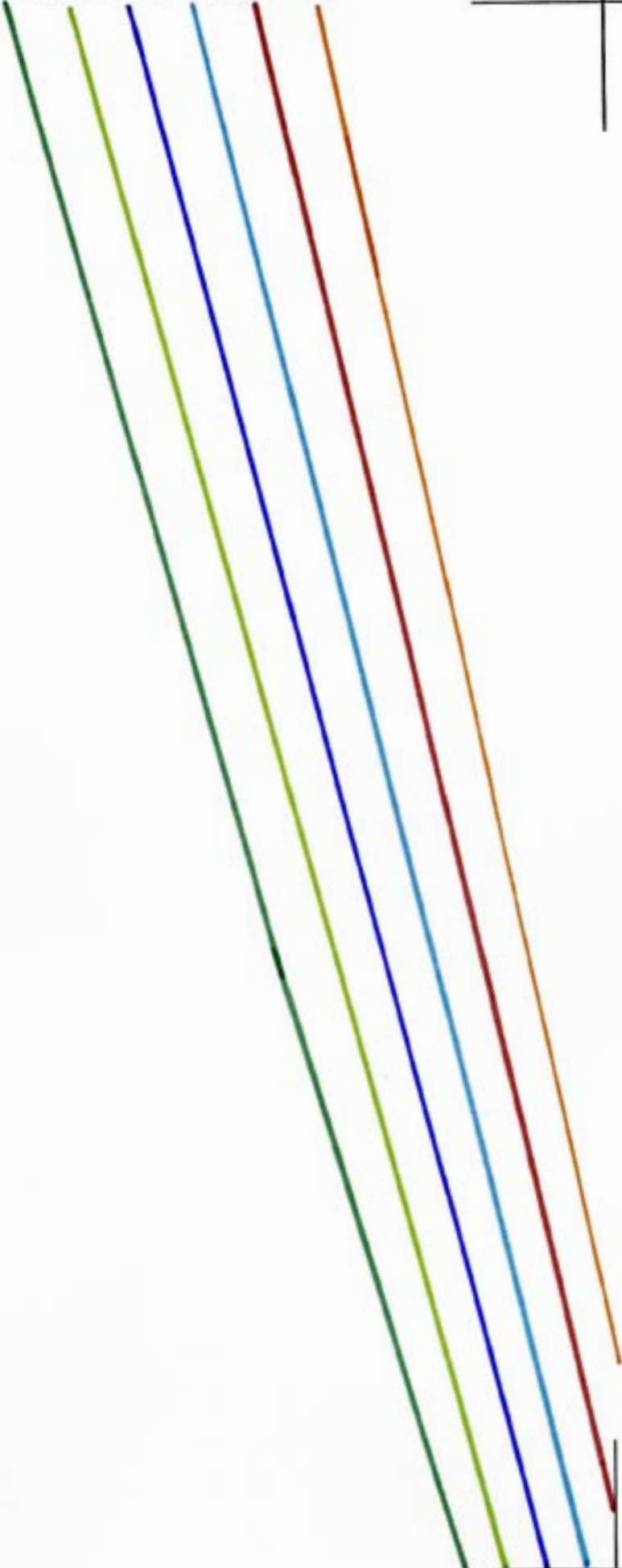

Women's Jacket 1: Sleeve - Normal (3 of 12)

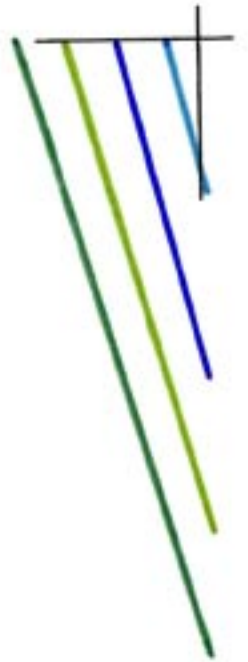

Women's Jacket 1: Sleeve - Normal (4 of 12)

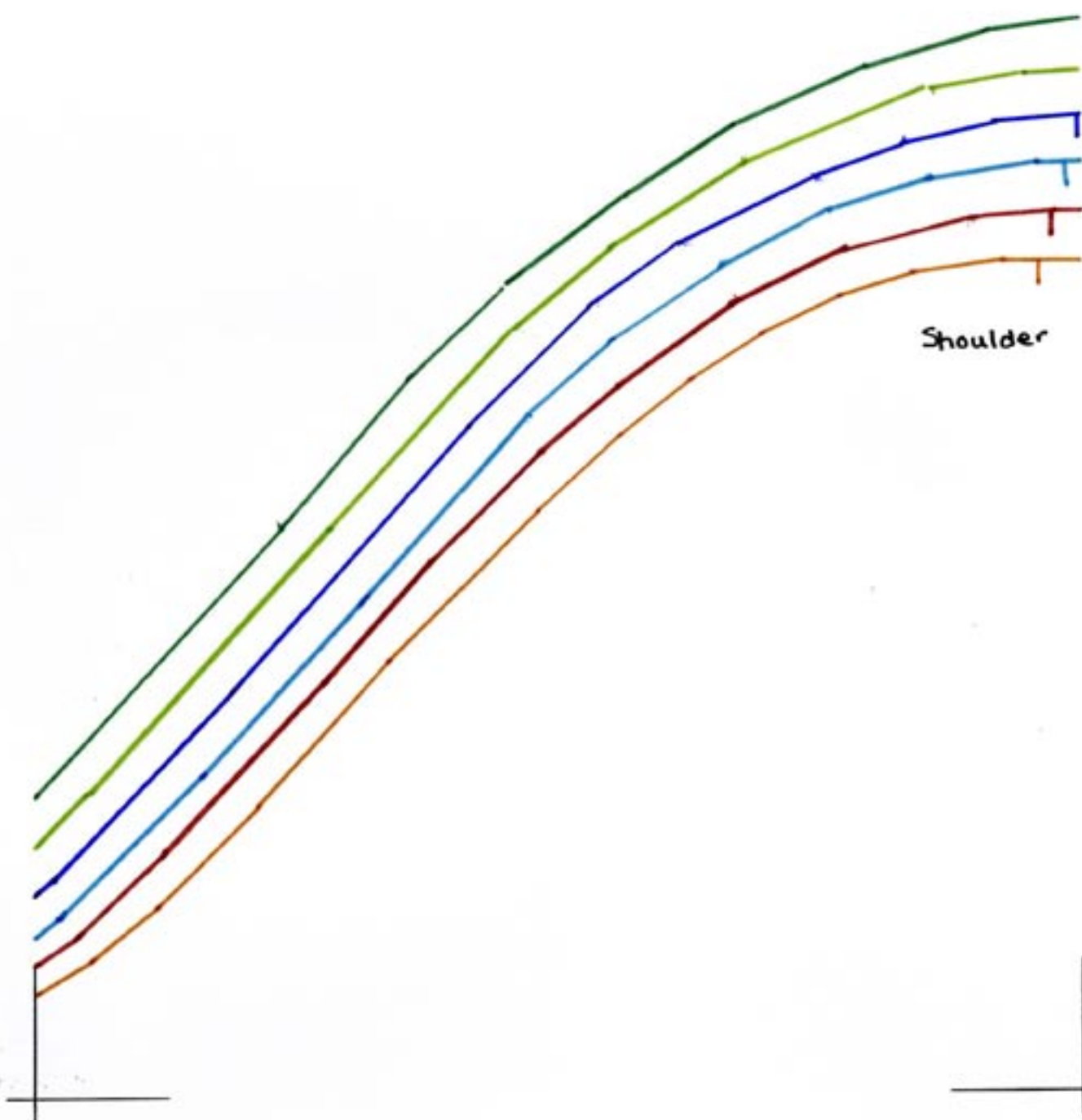

Women's Jacket 1: Sleeve - Normal (5 of 12)



Women's Jacket 1: Sleeve - Normal (6 of 12)



Cut here for Sleeve with wristband

Cut here for Sleeve without wristband.

Women's Jacket 1: Sleeve - Normal (7 of 12)

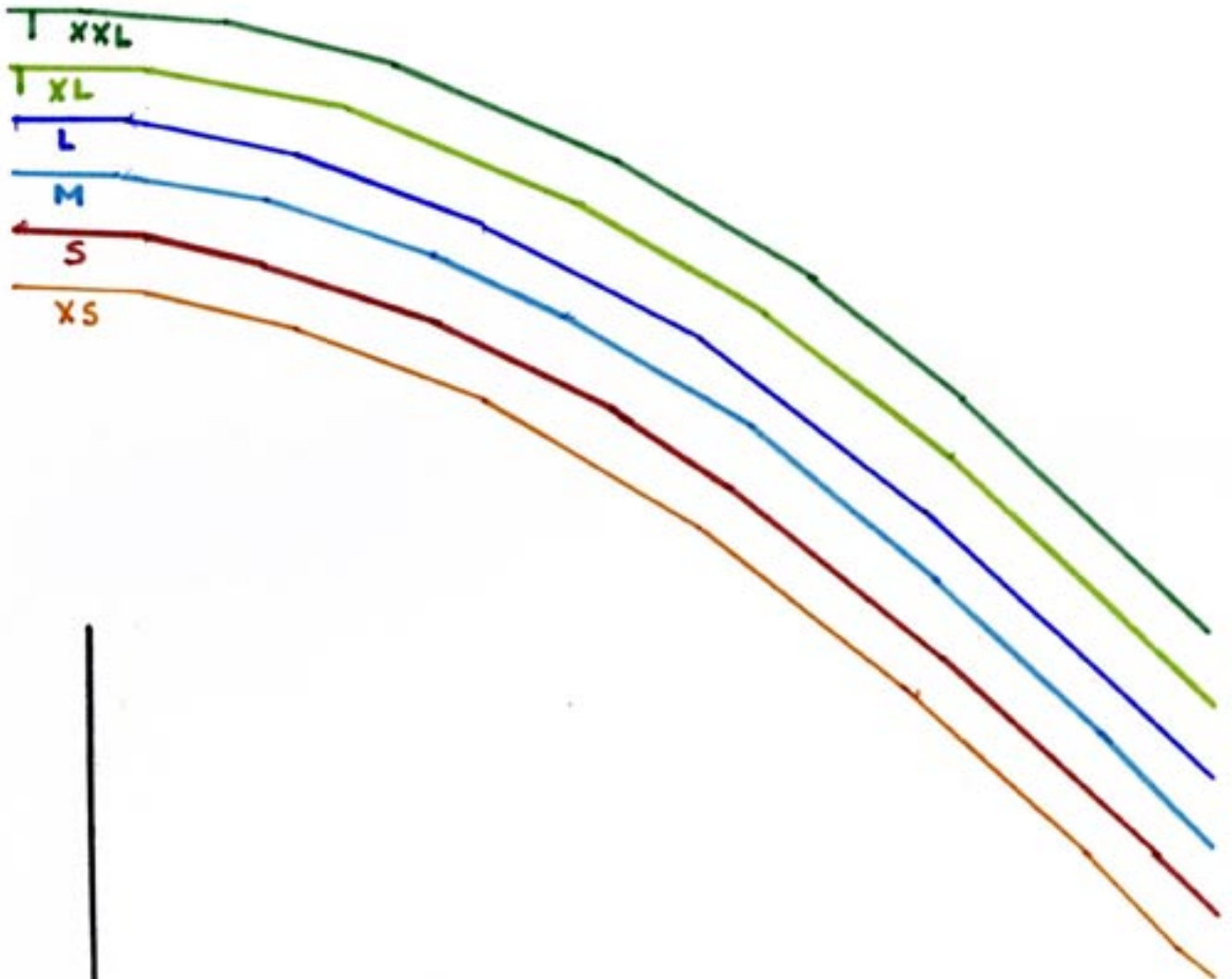



Women's Jacket 1: Sleeve - Normal (8 of 12)



Run of Fabric



Women's Jacket 1: Sleeve - Normal (9 of 12)



Women's Jacket 1: Sleeve - Normal (10 of 12)

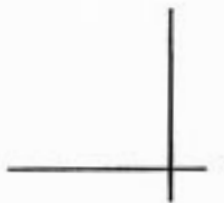
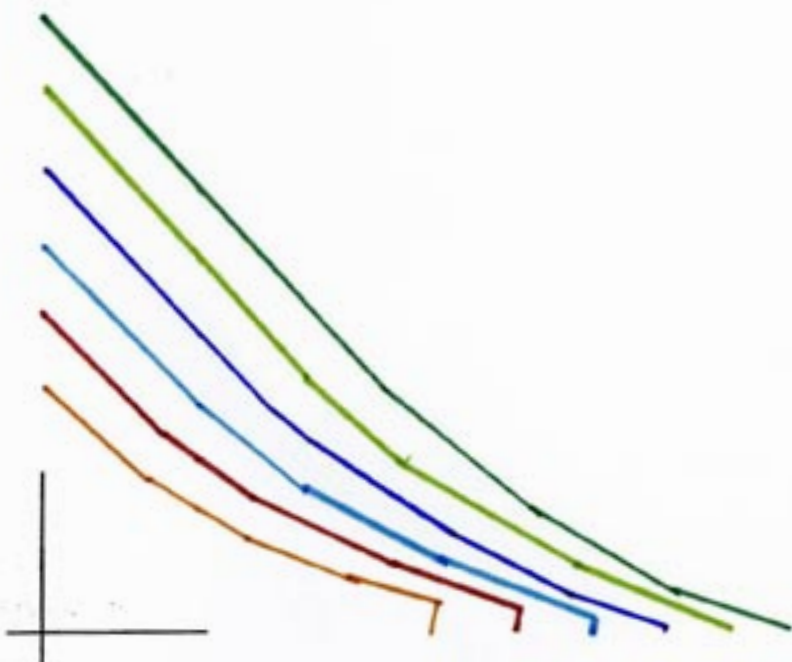

Women's Jacket 1: Sleeve - Normal (11 of 12)

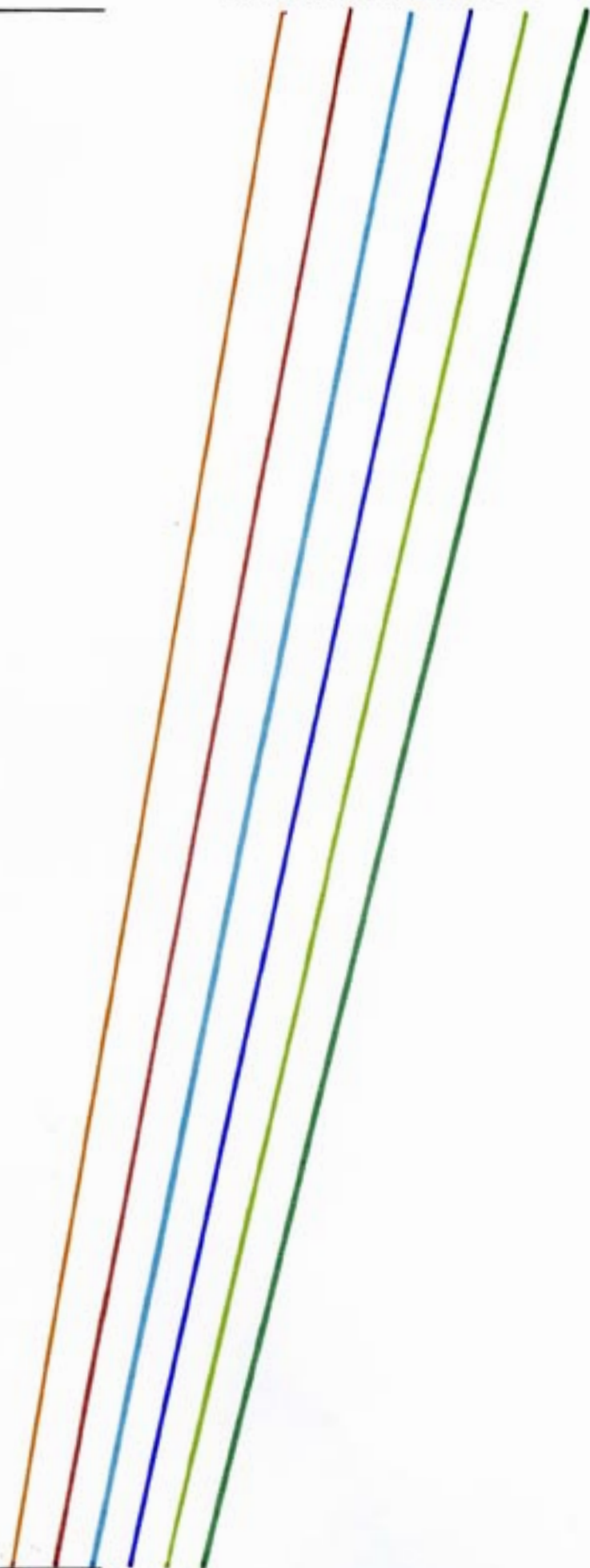

Women's Jacket 1: Sleeve - Normal (12 of 12)

